

# Simple Load One Trike Plus One Bike Rack v7.0 Parts List

Item	Tk1Rg1 v6.0 Qty	Item	Tk1Rg1 v6.0 Qty
Baggie 6 x 6, 4ml	1	Tilt-Up – 2" square black tube 34" long	1
Box Tk1Rg1 v7.0	1	Tilt Sides – Black 5" x 6 5/8" with 5 holes	2
Hex Head Armor 1/2"-13 x 1"	3	Tilt Insert - <b>1.25" or 2"</b> square black tube 16.5" long <b>(Depends on what size hitch)</b>	1
Lock Washer 1/2" Yellow Zinc	3	Trike Strut – 1.25" square black tube 47" long	1
Channel Nut 1/2 Thread 3/8 thk	3	Bike Vertical Bottom and Top – 1" x 1 5/8" aluminum slotted channel 24" long	2
Flg Head Grade 8 3/8-16 x 3"	7	Internal Strut Support (1/4" x 1" x 8")	1
Flg Head Grade 8 3/8-16 x 1"	2	Bike Steel Slotted Channel - Silver channel 1 5/8" x 1 5/8" x 38"	1
Flg Head Grade 8 3/8-16 x 2"	4	Trike Steel Slotted Channel - Silver channel 1 5/8" x 1 5/8" x 24" long	1
Flg Head Grade 8 3/8-16 x 1 3/4"	12	Trike Crossbar black channel 1 5/8" x 1 5/8" x 36" long	1
Hex Head Bolt 3/8" x 4 1/2" Zinc	1	V-Tray for Bike 32" Long	2
Hex Head Bolt 3/8"x 5" Zinc	1	V-Tray for Trike Passenger Side 36" long	1
Hex Head Bolt 3/8"x1 5/64" with hole	1	V-Tray for Trike Driver Side 36" long	1
Hex Head Bolt 3/8"x3 5/64" with hole	1	Cam Buckle Strap 54"	2
3/8" nut with slots	2	Cam Buckle Strap 18"	7
Clevis Pin 3/8-16 x 3"	1	U-Clamp 1" high for Trike Strut U-Clamp 1 5/8" high for Trike Crossbar	1 1
Hair Pin for Clevis Pin	1	7" J-Bolt Assembly	1
Flat Washer Regular 3/8" Armor Coat	19	L-Bracket	3
Flat Washer Thick 3/8"	2	Flat Bracket Strap Holder-2 Hole	1
Lock Washer 3/8 Yellow Zinc	2	Flat Bracket Strap Holder-3 Hole	1
Nut 3/8-16 SS Self-Lock	21	Corner Bracket (Seat Post Holder)	2
Square Washer	10	Long Wheel Stop with 2 Holes	2
Square Nut	8	Shims <b>(Only for a 1.25" Hitch)</b>	2
Spacer (2" long)	2	Anti-Rattle Bolt Assembly <b>(Only on the 1.25" Hitch)</b>	1
Cotter Pins	2		

# **CycleSimplex Bike Rack Assembly Instructions**

**Simple Load One Trike Plus One Bike Rack  
V7.0**

## **Precautionary and Maintenance Information:**

All straps must be used at all times.

When you are not carrying trike(s)/bike(s), you can either leave the straps attached through the slots or remove them. If you leave the straps on the rack, they should be connected just as they would with the trike or bike on the rack, otherwise they may be lost.

There is always some flex in metal. Because of this you should check and tighten bolts before each use.

You should check the straps for wear before each use and replace if they show any wear.

This trike or bike rack will extend quite a distance behind your vehicle. Caution must be used not to “bottom out” on sharp dips or rises in your path. Your rack or trike(s)/bike(s) may also extend beyond the sides of your vehicle so caution is required not to hit the rack or your trike(s)/bike(s) on other objects.

## **Liability Information**

CycleSimplex, LLC’s liability from all causes is limited to the purchase price of the trike or bike rack.

## **Warranty Information**

This trike or bike rack may be returned unused for any reason by the purchaser to CycleSimplex, LLC within 15 days of its receipt by the purchaser. For full refund, returns must be packaged so that no damage occurs to the rack in shipment and the trike or bike rack is received by CycleSimplex in like new condition. If the rack arrives damaged the cost of repairing the damage may be deducted from the refund.

CycleSimplex, LLC warrants the trike or bike rack from defects in material or workmanship for 90 days from the date the purchaser receives the product. During that 90 day period, CycleSimplex, LLC will at its sole discretion either replace defective components or refund the full purchase price of the trike or bike rack upon return of the trike or bike rack in like new condition.

## Material List Simple Load One Trike Plus One Bike Rack v7.0

Task	Carriage/Hex Head Bolts	Flange Head Bolts	Round Silver Washer	Lock Washer	Nylon Washer	Self Lock Nuts	Channel Nuts	Spacer	Square Washer	Square Nut
Attach the 38" Bike Channel with Internal Support to the Tilt-up		2 – 3/8" x 3"				2				
Attach driver's side 32" Bike V-Tray to the 38" Bike Channel		2 – 3/8" x 1 3/4"							2	2
Attach passenger side 32" Bike V-Tray to the 38" Bike Channel		2 – 3/8" x 1 3/4"							4	2
Attach Long Wheel Stop with 2 holes to bike passenger side V-Tray		2 – 3/8" x 1 3/4"	2			2				
Attach Strap Holder 3 hole to Right V-Tray		2 – 3/8" x 1 3/4"	2			2				
Attach Bike Vertical Top to Bike Vertical Bottom		2 – 3/8" x 1"		2					2	2
Attach L-Bracket for Bike Vertical to Tilt-Up	1 – 3/8" x 3 5/64" Hex with hole	1 Cotter Pin	6			1 Slots				
Attach Bike Vertical Bottom to L-Bracket	1 – 3/8" x 1 5/64" Hex with hole	1 Cotter Pin	5			1 Slots				
Attach Corner Brackets to Bike Vertical Top		2 – 3/8" x 2 1/2"				2				
Attach 24" Trike Channel to Trike Strut Square Tube		2- 3/8" x 2"				2				
Attach driver side 36" Trike V-Tray to 24" Trike Strut Square Tube with Strap Holder 2 hole and 2 Spacers	1 – 3/8" x 5" 1 – 3/8" x 4 1/2"		2(Thick) 2(Reg)			2		(2) 2"		
Attach passenger 36" Trike V-Tray to Trike Channel		2 – 3/8" x 1 3/4"							2	2
Attach Long Wheel Stop with 2 holes to left Trike V-Tray		2 – 3/8" x 1 3/4"	2			2				
Attach 36" Crossbar to Trike Strut-Square Tube using the U-Clamp		2 – 3/8" x 2"				2				
Attach Tilt Mechanism Sides to Tilt Up	1 – 3/8" x 3" Clevis Pin	1 – 3/8" x 3"				1				
Attach Tilt Mechanism Sides to Tilt Insert		2 – 3/8" x 3"				2				
Attach Trike Strut to Tilt-Up using U-Clamp		2 – 3/8" x 3"				2				

J-Bolt	<b>7" J-Bolt Assembly</b>									
<b>3/8" Totals</b>		<b>2 Cotter Pins</b>	<b>19+2</b>	<b>2</b>		<b>21+2</b>		<b>2</b>	<b>10</b>	<b>8</b>

Task	Carriage Head Bolts/Pins	Flange/Hex Head Bolts	Round Silver Washer	Lock Washer	Nylon Washer	Self Lock Nuts	Spacer	Channel Nuts	Square Nut	Square Washer
Attach (2) L-Brackets to Trike Crossbar		<b>2 - 1/2" x 1"</b>		2				2		
Attach 36" Crossbar to Trike Strut-Square Tube using the U-Clamp (middle hole in U-Clamp)		<b>1 - 1/2" x 1"</b>		1				1		
<b>1/2" Totals</b>				<b>3</b>				<b>3</b>		

# One Trike Plus One Bike Rack v7.0



Trike Strut – Square Tube (The Delta Is 47” Long and the Tadpole Is 36” Long)



Trike Crossbar



Tilt Up for One Trike and One Bike rack



Tilt Insert (May be 2” or 1.25” square)



L-Bracket



Tilt Mechanism Sides



Trike or Bike Channel (steel), Bike Vertical Top and Bottom (Aluminum)



Corner Bracket

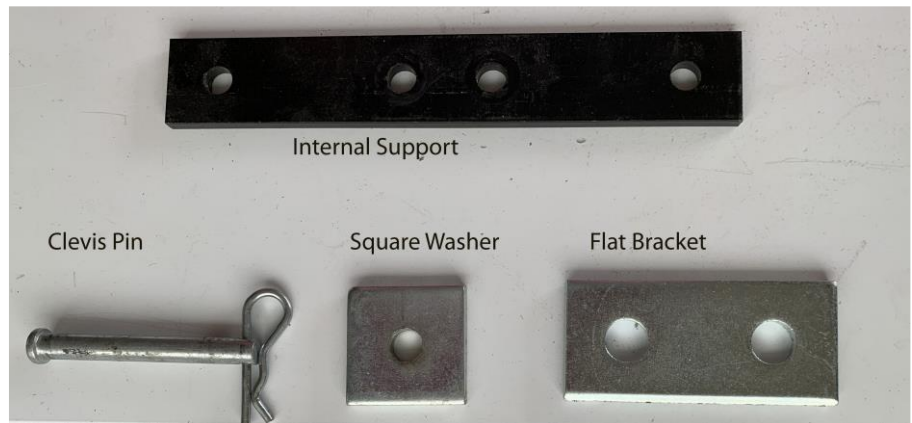

**You may not have all of these**



V-Tray Trike Passenger Side



V-Tray Trike Driver Side



V-Tray Bike Both Driver Side and Passenger Side

**Figure 1:** The strut channel comes in various sizes. When we describe something as strut channel, it will look like the following with 3” long slots in the bottom:

When attaching components to strut channel, it is critical that all Channel Nut Assemblies must be tightened with the channel nut under the rail as shown below. The grooves in the channel nut must be up and under the rail of the strut channel. Your channel nut will not have a spring under it.

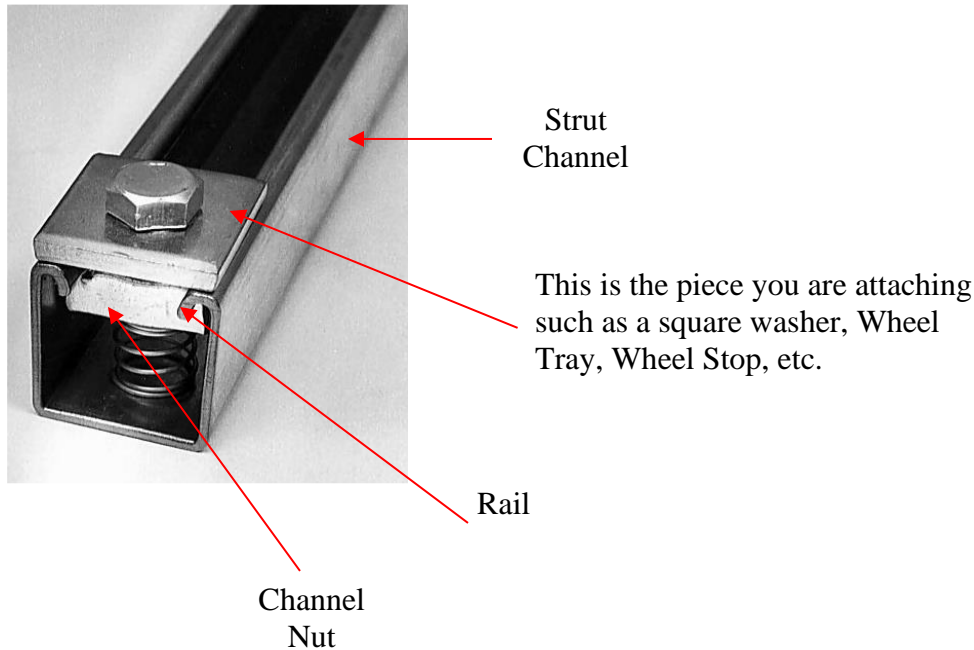

**Figure 2:** All Bolts requiring a Channel nut must be assembled in the following fashion. This is a Bolt and Channel Assembly. This does not come as an assembled part. You have to assemble each as required in the instructions.

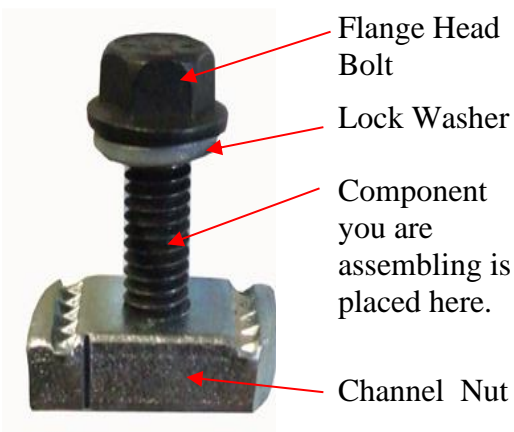



**Step 1A:** You will create one of each U-Clamp Assembly to be used later

- (1) Trike Crossbar to the end of the Trike Strut
- (2) Trike Strut to the Tilt-Up

**1. Trike Crossbar to Trike Strut U-Clamp (1 5/8" Deep)**



**2. Trike Crossbar to Trike Strut U-Clamp**

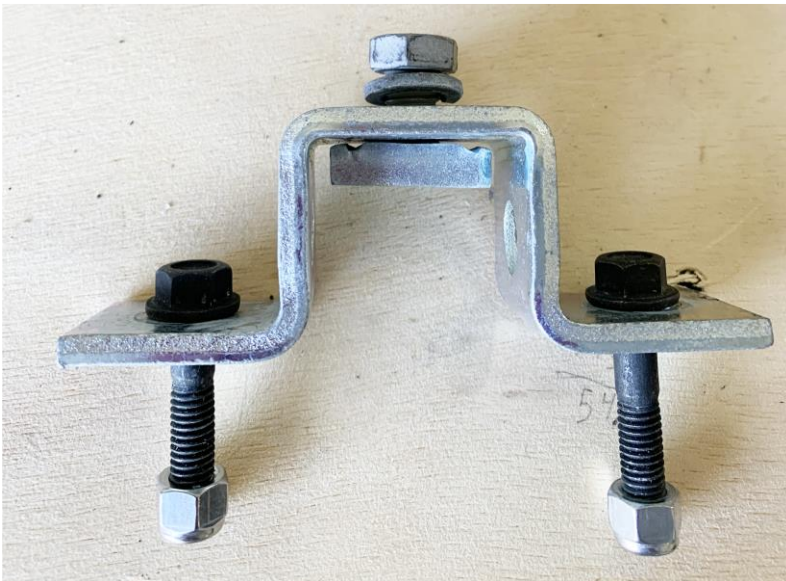

**Step 2: Assemble Tilt Mechanism Sides, Tilt Up and Tilt Insert as shown in the picture below**

**If you have a 1.25" rack, do Step 2A. If you have a 2" rack, you will not use the Shims.**

**Step 2A**

Place the two Shims on each side of the Tilt Insert so that they are over the two holes in the Tilt Insert. Pass the two 3/8" x 3" black Flange Head bolts through the two holes C and D in the bottom of the Tilt Sides, then the Shim, the Tilt Insert, the other Shim and the other Tilt Side (the shorter distance from Hole B to Hole C should be toward the bottom of the Tilt Sides). Place a 3/8" round silver washer and 3/8" self-locking nut on the end of the two bolts. Finger tighten. Do not tighten all the way yet.

Pass a 3/8" x 3" black flange head bolt through the Tilt Sides and the Tilt Up in Hole A. Place a 3/8" round silver washer and 3/8" self-locking nut on the end of this bolt. Finger tighten the nut

Pass the Clevis Pin through Hole E. Insert the Hair Pin into the hole in the end of the Clevis Pin.

Tighten all nuts

If you want to tilt the rack up, remove the Clevis Pin from Hole C, tilt the Tilt-Up up and place the Clevis Pin in Hole B.

**Step 2B**

If you have a 2" rack you will do all the steps in Step 3A except you will not have the 2 Shims

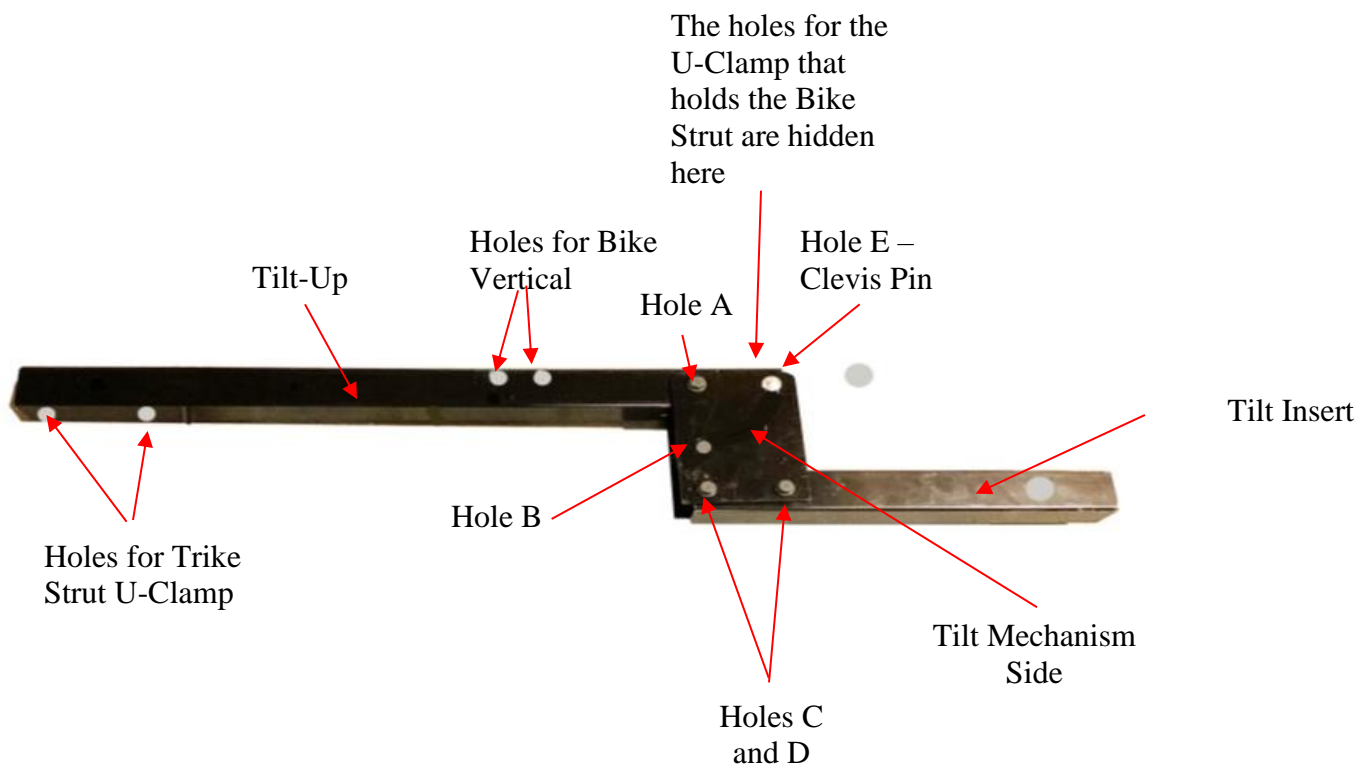

### Step 3: Assemble the Bike Channel and Bike V-Trays to the Tit-Up

**3A:** The 36" Bike Channel should extend more on the driver's side than the passenger side. How much more will depend on the radius of your bike's front wheel. It should extend the radius of your wheel more to the driver's side.

Place the Internal Support inside the Bike Channel which is a piece of metal 8" x 1" and ¼" thick with 4 holes in it. The Internal Support should be placed over the two holes in the Tilt-Up closest to the vehicle. Two flange head bolts should be placed through the Strut Support, Bike Channel and the Tilt-Up with a flat washer and a self-lock nut on each bolt.



**We will now assemble the 32" Bike V-Trays.**

**3B1:** Place a Long Wheel Stop on one of the 32" V-Trays using the two holes that are 1 7/8" apart at the end of the V-Tray. This will be the passenger side V-Tray.

**3B2:** Pass two 1 3/4" flange head bolts through the holes in the Wheel Stop and then through the two holes closest to the end of the V-Tray. Place two flat washers on each bolt and a self-lock nut on the end of the bolt. Do not tighten all the way. Place an 18" strap under the Wheel Stop and between the bolts and slightly tighten the nuts. (Strap not shown) You will tighten the nuts all the way after you adjust the straps when you first place your bike on the rack.

**3B3:** In the other two remaining holes place a 1 3/4" flange head bolt in each hole in the V-Tray. Slide a square washer onto each of the bolts under the V-Tray and then screw two square nuts onto the bolts. Screw the square nut onto the bolt so that the bolt comes just through the square nuts. You will later slide the flat washers on top of the Bike Channel and the square nut under the rails of the Bike Channel. This will be the driver's side Bike V-Tray

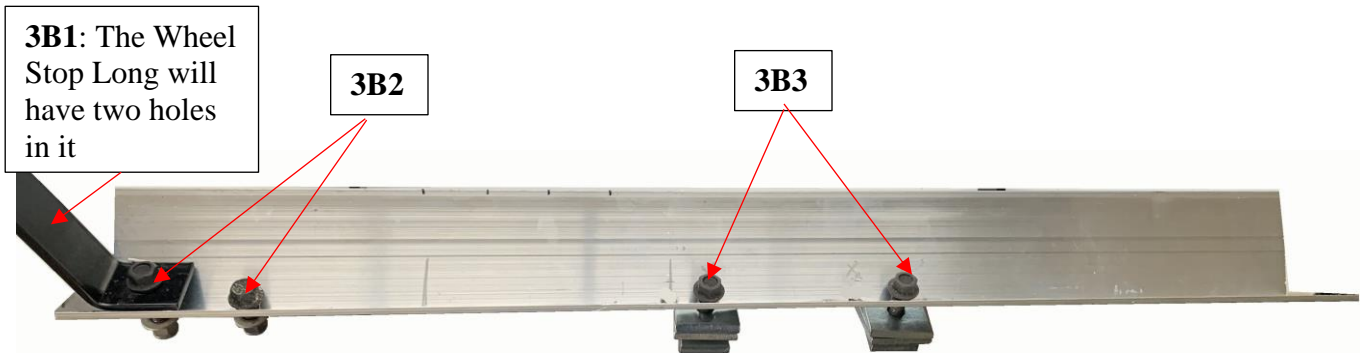

**3C1:** Place a Flat Bracket Strap Holder on the other of the 32" V-Trays using the two holes that are 1 7/8" apart at the end of the V-Tray. This will be the driver side V-Tray.

**3C2:** Pass two 1 3/4" flange head bolts through the two holes in the Flat Bracket Strap Holder and then the V-Tray. Place one flat washer on each bolt and a self-lock nut. Place an 18" strap under the Flat Bracket and between the bolts of the Flat Bracket Strap Holder and slightly tighten the nuts. (Strap not shown) You will tighten the nuts all the way after you adjust the straps when you first place your bike on the rack. This will be the passenger side Bike V-Tray.

**3C3:** In the other two remaining holes place a 1 3/4" flange head bolt in each hole in the V-Tray. Slide a square washer onto each of the bolts under the V-Tray and then screw two square nuts onto the bolts. Screw the square nut onto the bolt so that the bolt comes just through the square nuts. You will later slide the flat washers on top of the Bike Channel and the square nut under the rails of the Bike Channel. This will be the passenger's side Bike V-Tray.

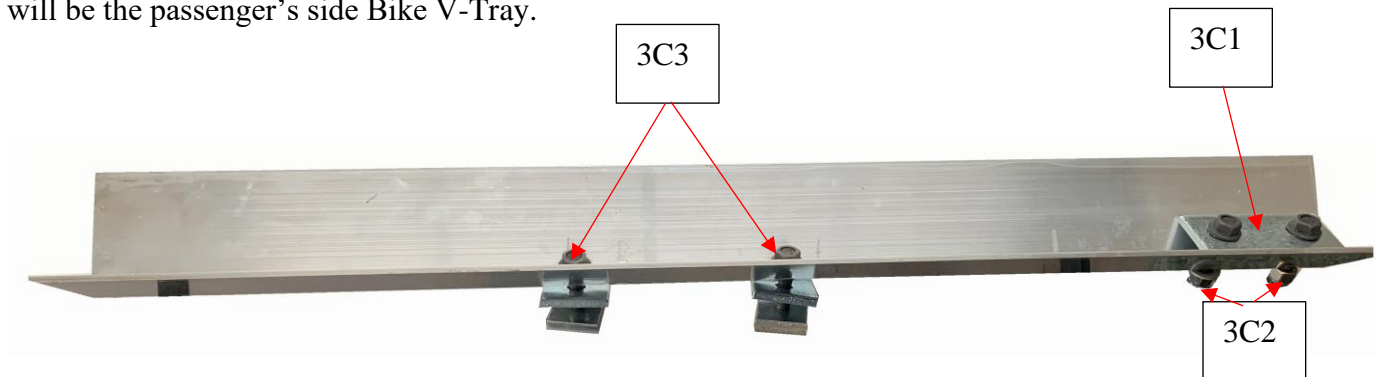

**Step 4:** We now will assemble together the Bike Strut Channel and the two V-Trays called the Bike Strut Assembly

First you will slide each of the V-Tray Assemblies you made in Step 3 onto the Bike Strut Channel. We are showing below the Passenger Side V-Tray Assembly with two flat washers. The Driver Side V-Tray Assembly will slide onto the Bike Strut Channel from the other side. **Please Note: The Passenger Side V-Tray Assembly with two square washers on each bolt will slide into the right side of the Bike Strut Assembly and not as it is shown sliding into the left side. The Driver Side Bike V-Tray Assembly with one square washer on each bolt will slide into the left side of the Bike Channel.**

The two square washers go on top of the Bike Channel and the square nut goes under the rails of the Bike Channel as shown in the picture below. Slide the V-Tray Assemblies in far enough so that the square washers sit completely on the rails of the Bike Strut Channel.

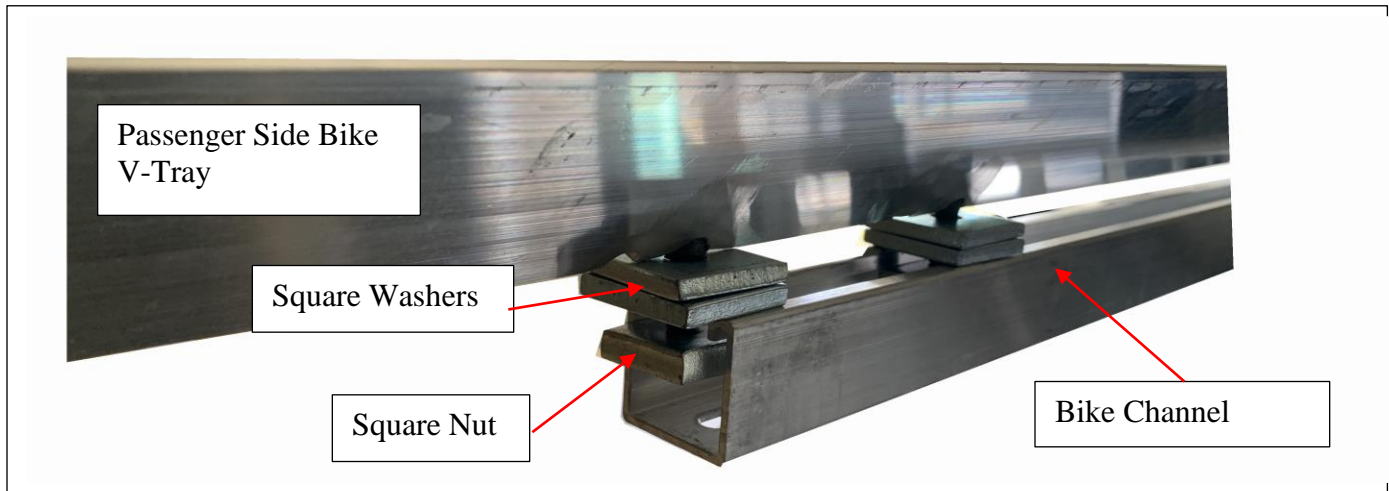

After completion of Step 4 the assembly should look like the picture below. The V-Tray driver side assembly can slide over the passenger side assembly so as to adjust for your bike's length. Two straps will go on the Long Wheel Stop, one through the slots and the second between the two bolts on the Long Wheel Stop around your tire. The third strap will go on the other end under the Strap Holder. Once you adjust for the length of your bike, tighten all bolts. Please note that the Passenger Side V-Tray will sit on top of the Driver Side V-Tray Assembly so that they can slide over each other to adjust for the bike's wheelbase.

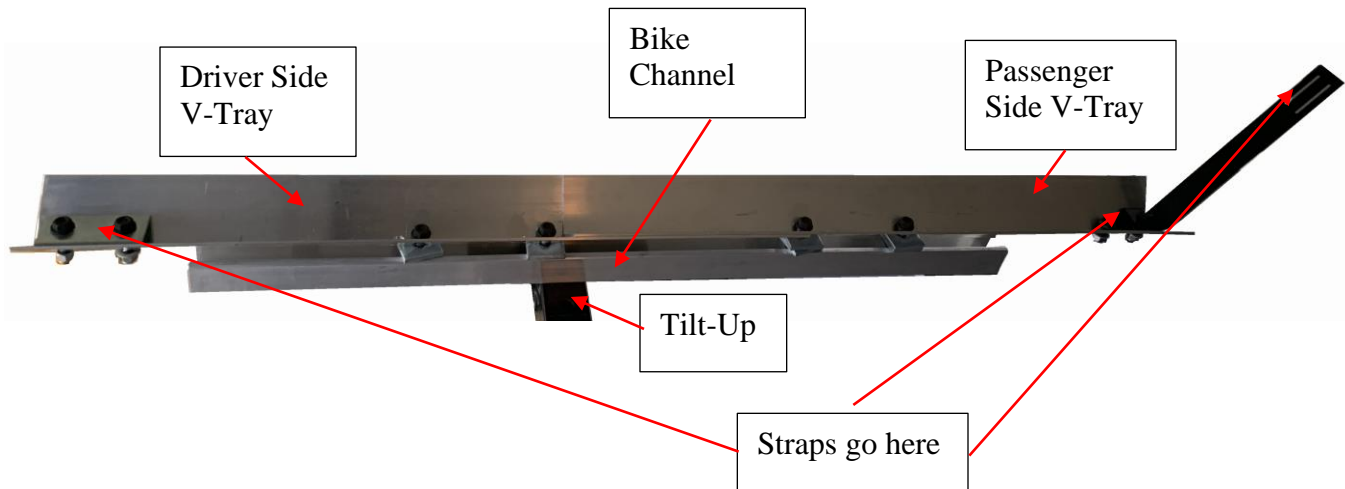

**Step 5–Assemble the Trike Strut – Square Tube and Trike Channel Assembly as shown below:**

**5A: If you have a delta trike, use this Step 5A.** Lay the Trike Strut Channel (24”long) and the Trike Strut - Square Tube (1.25” x 1.25” x 47” long) as shown below so that the total length of the two components is your delta trike’s wheelbase plus 10 inches

**5B: If you have a tadpole trike, use this Step 5B.** Lay the Trike Strut Channel (24” long) and the Trike Strut - Square Tube as shown below so that the total length of the two components is the distance from the back edge of the rear wheel to the axel of the front wheels plus 2”.

**For either type trike do the following:**

**5C:** Fasten the 24” long Trike Channel on top of the Trike Strut – Square Tube. Using the last two holes to the left end of the Trike Strut – Square Tube. Pass a 3/8” x 2” flange head bolt through the Wheel Extension and the last hole to the left in the Trike Strut – Square Tube. Place a flat washer and then a self-lock nut on the bolt and finger tighten.

**5D:** Do this again for the next to last hole to the left of the Trike Strut – Square Tube and the Wheel Extension. This will be depicted in below.

Tighten both nuts

This Assembly will be attached to the Tilt-Up with a U-Clamp later

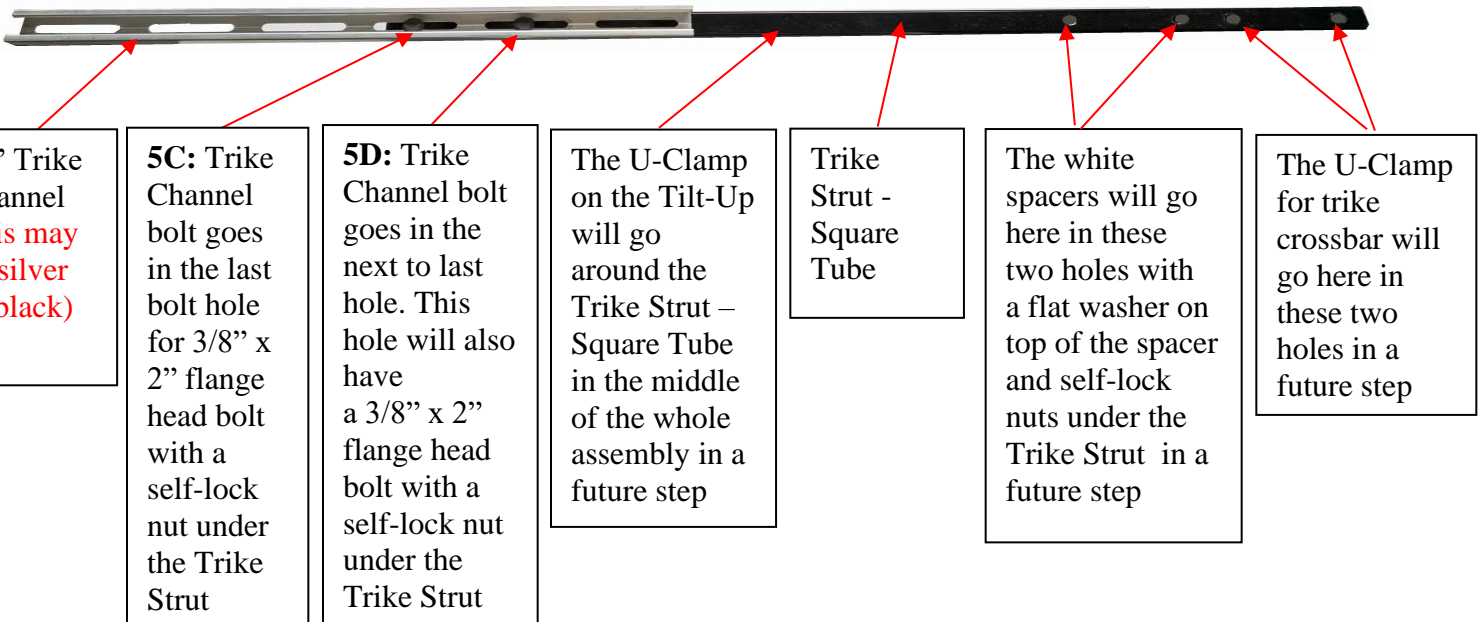



**Step 6: Attach the Trike Strut - Square Tube and Trike Channel Assembly made in Step 5 to the Tilt-Up using the U-Clamp.**

As shown below you are going to place the U-Clamp over the Trike Strut – Square Tube and attach the 1” U-Clamp to the Tilt-Up using the two 3/8” x 2” flange head bolts in Step 1. The U-Clamp will not be snug against the Trike Strut- Square Tube so you will have to put a Square Nut inside the U-Clamp as shown below. Gradually tighten each 3/8” bolt evenly so that the U-Clamp holds the Trike Strut – Square Tube and the Square Nut tightly. It is OK to bend each arm of the U-Clamp a little as you tighten the bolts.

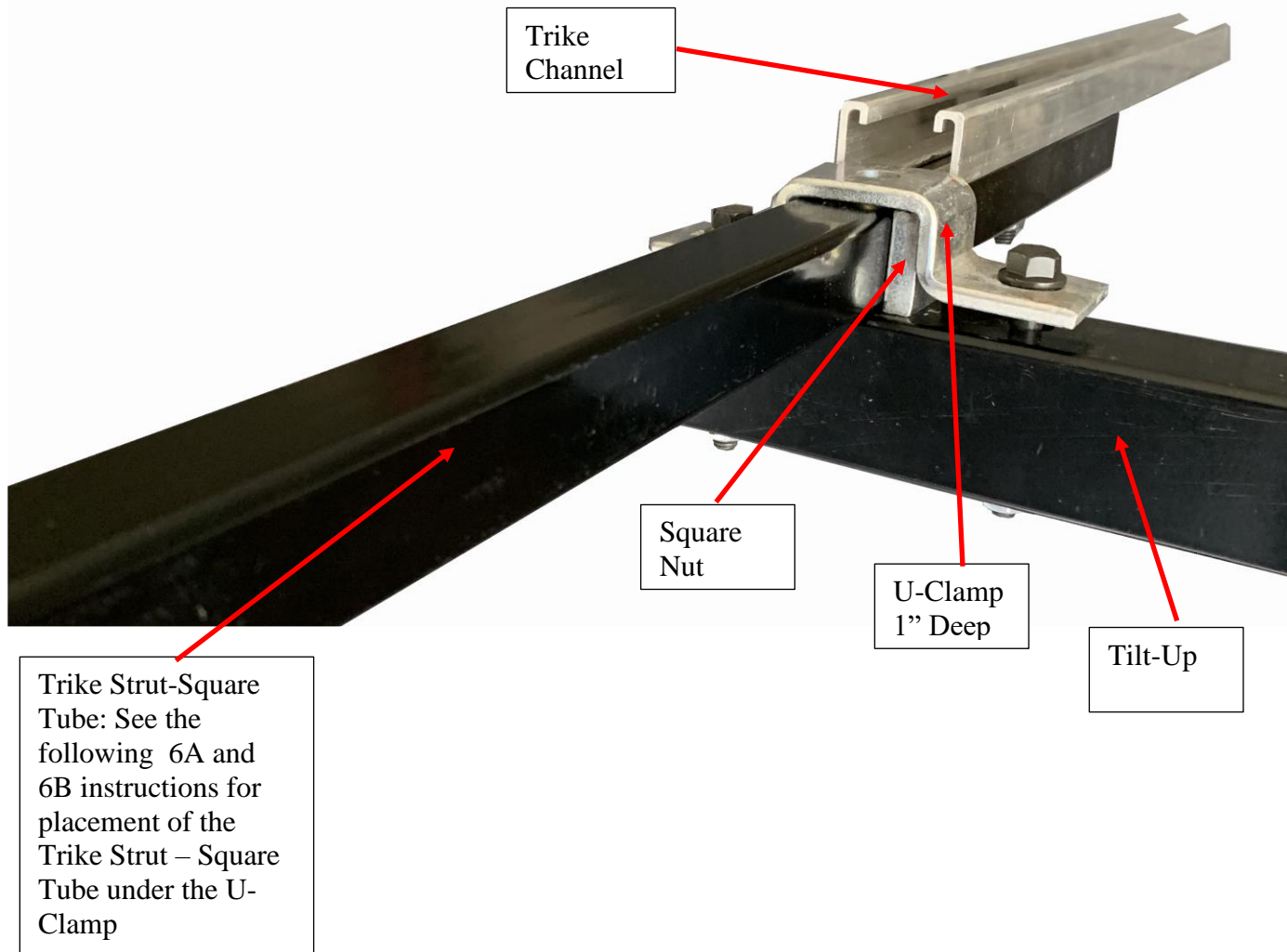

**If you Have a delta rack, use Step 6A below:**

**6A:** Align the Trike Strut – Square Tube and Wheel Extension Assembly within the U-Clamp and over the Tilt-Up so that the Assembly is 5” longer on the side with the Trike Wheel Extension

**If you have a tadpole rack, use Step 6B below:**

**6B:** Measure the distance from the back edge of your rear tire to the end of the boom by the front wheels. Divide that length by 2. This is the distance from the outside end of the Wheel Extension to the U-Clamp in the picture above. You may have to slide the Trike Strut – Square Tube within the U-Clamp later to align the trike behind the vehicle.

**Step 7: Assemble the Trike V-Tray Passenger Side and attach it to the Trike Channel.** The Trike V-Trays are both 36" long. Refer to Step 3 for assembly Instructions.

**7A:** Attach the Wheel Stop to the V-Tray with two 3/8" x 1 3/4" flange head bolts. Put a flat washer next to the head of each bolt and pass the bolts through the V-Tray and place a flat washer and a self-lock nut on each bolt and tighten. **The picture shows only one bolt**

**7B:** Place a flat washer next to the heads of two 3/8" x 1 3/4" flange head bolts and pass the bolts through the trike passenger side V-Tray as shown below. The bolts go through the 4<sup>th</sup> and fifth holes from the end. There will be a square washer and square nut on the ends of the bolts. Slide the V-Tray into the Trike Channel to the appropriate distance for the wheelbase of your trike.

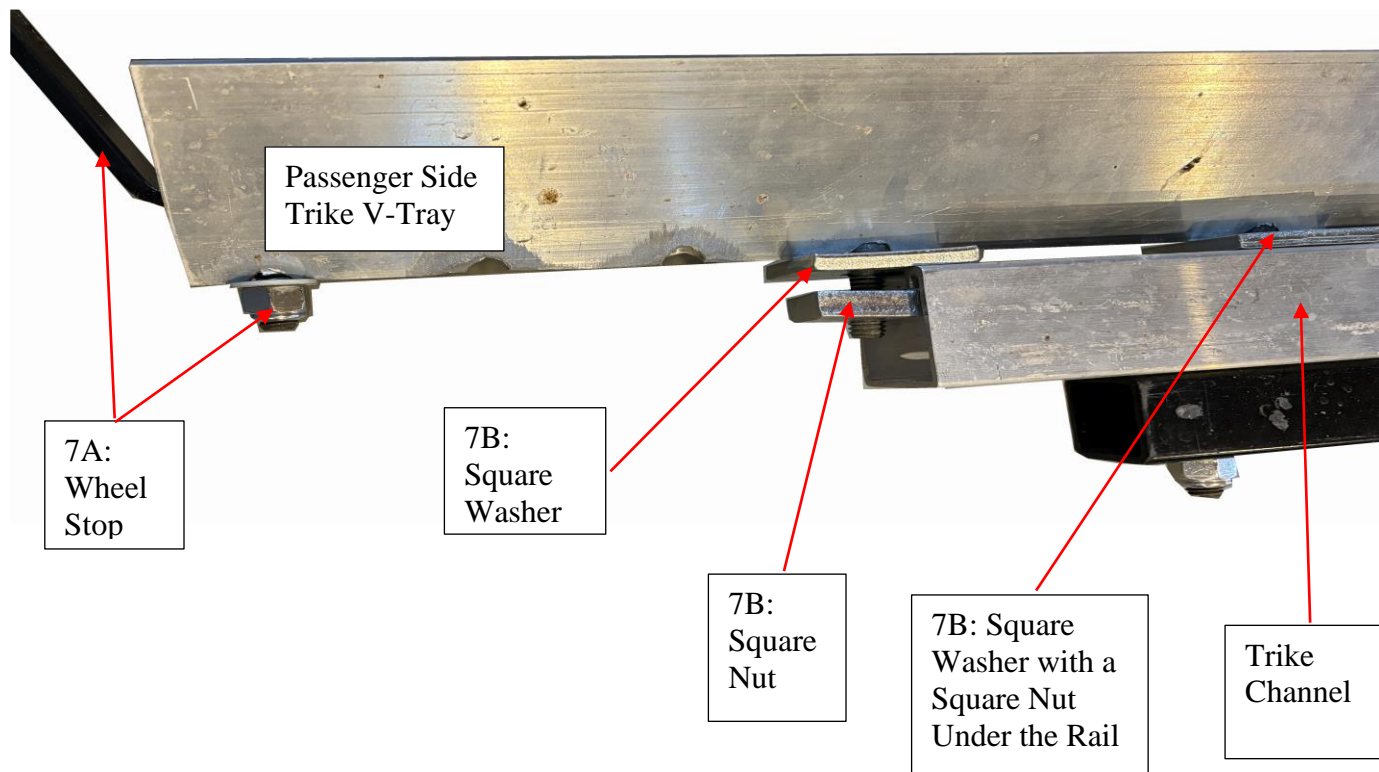



**Step 8: Attach the Driver Side V-Tray to the Trike Strut – Square Tube**

8A: Set the Trike V-Tray Driver Side on top of the Trike V-Tray Passenger Side as shown in the picture below. Place the two-hole flat bracket over the end hole in the trike v-tray and pass the 3/8" x 5" hex head bolt through the flat bracket the V-Tray, the spacer and the trike strut square tube. The spacer should have a thick 3/8" washer between the spacer and the v-tray. Place a 3/8" self-lock nut on the end of the bolt and tighten a little.

8B: Do the same with the 3/8" x 4 1/2" hex head bolt with the other hole in the v-tray.

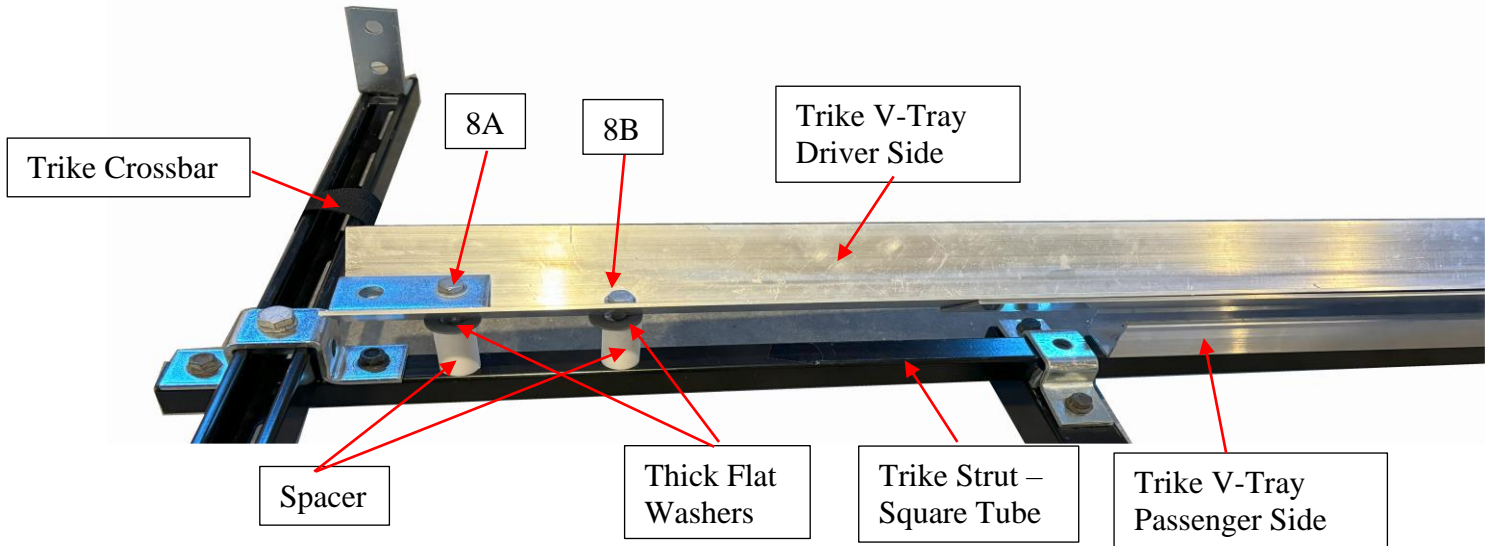

**Step 9 – Assemble the Trike Crossbar to the Trike Strut – Square Tube.**

The Trike Crossbar U-Clamp and Trike Crossbar will be placed on the passenger end of the Trike Strut – Square Tube indicated above

The U-Clamp (Step1) will attach the Crossbar to the Trike Strut as shown below.

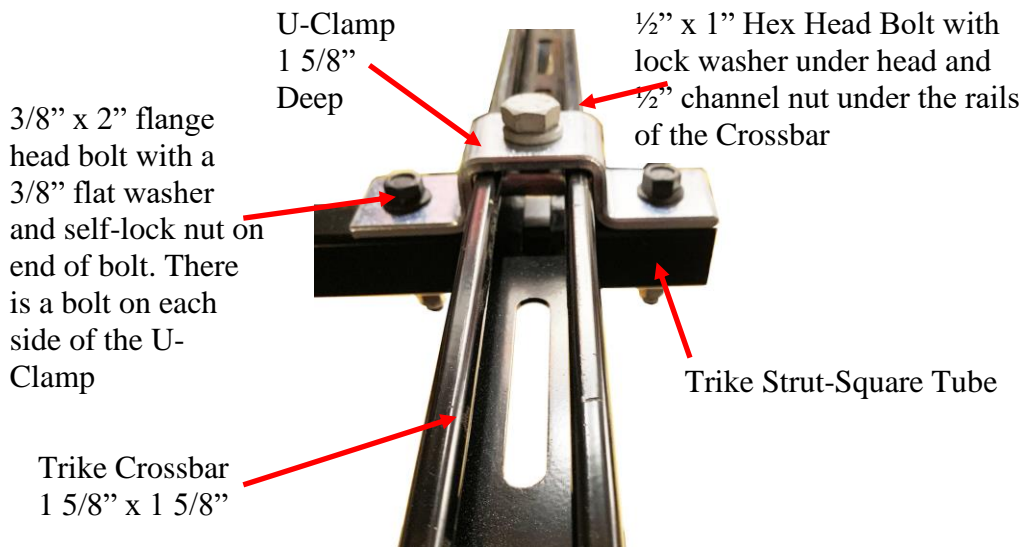

**Step 10: Attach the (2) L-Brackets to the Trike Crossbar:** Measure the distance from the outside of one tire to the outside of the other tire. This will be the distance between the L-Brackets. Place a ½” lock washer under the head of each 1” x ½” hex head bolt and place the bolts through each L-Bracket.

Place a channel nut on the end of the bolts. Slide the channel nuts inside the Trike Crossbar so that the channel nuts are on the rails of the Crossbar and tighten so that the L-Brackets are on the outside of each wheel.

The L-Brackets can also go to the inside of each wheel.



1” x ½” hex head bolt with lock washer under the head and channel nut on the end

**Step 11: Fasten Bike Vertical Top on top of the Bike Vertical Bottom and assemble the Seat Post Holder Assembly:**

- 11A. Put the slotted aluminum 1" x 1 5/8" x 24" Bike Vertical Top Channel under the same size 24" Bike Vertical Bottom Channel as shown in the picture below. Place a 3/8" lock washer on two 3/8" x 1" flange head bolts. Pass the bolts up through Top Vertical Channel then a square washer and through the Bottom Vertical Channel as shown in the picture below and secure with the 3/8" Channel Nut under the rails of the Bottom Vertical Channel. Make certain the channel nut is under the rails of the Bottom Vertical Channel.
- 11B. Bolt the Seat Post Corner Brackets on each side of the Bike Vertical Top using (2) 3/8" x 2" flange head bolts. Pass the bolts through the Corner Brackets and place a 3/8" self-lock nut on the end of the bolt.
- 11C. Place the J-Bolt through the corner hole in the Corner Bracket and the Bike Vertical top. Place the black round spacer on the J-Bolt then a flat washer, then a lock washer, then another flat washer and then the hand knob and finally the self-lock nut on the J-Bolt. Make certain the J-Bolt slides easily.

Peel off the protective paper and place the rubber Pad

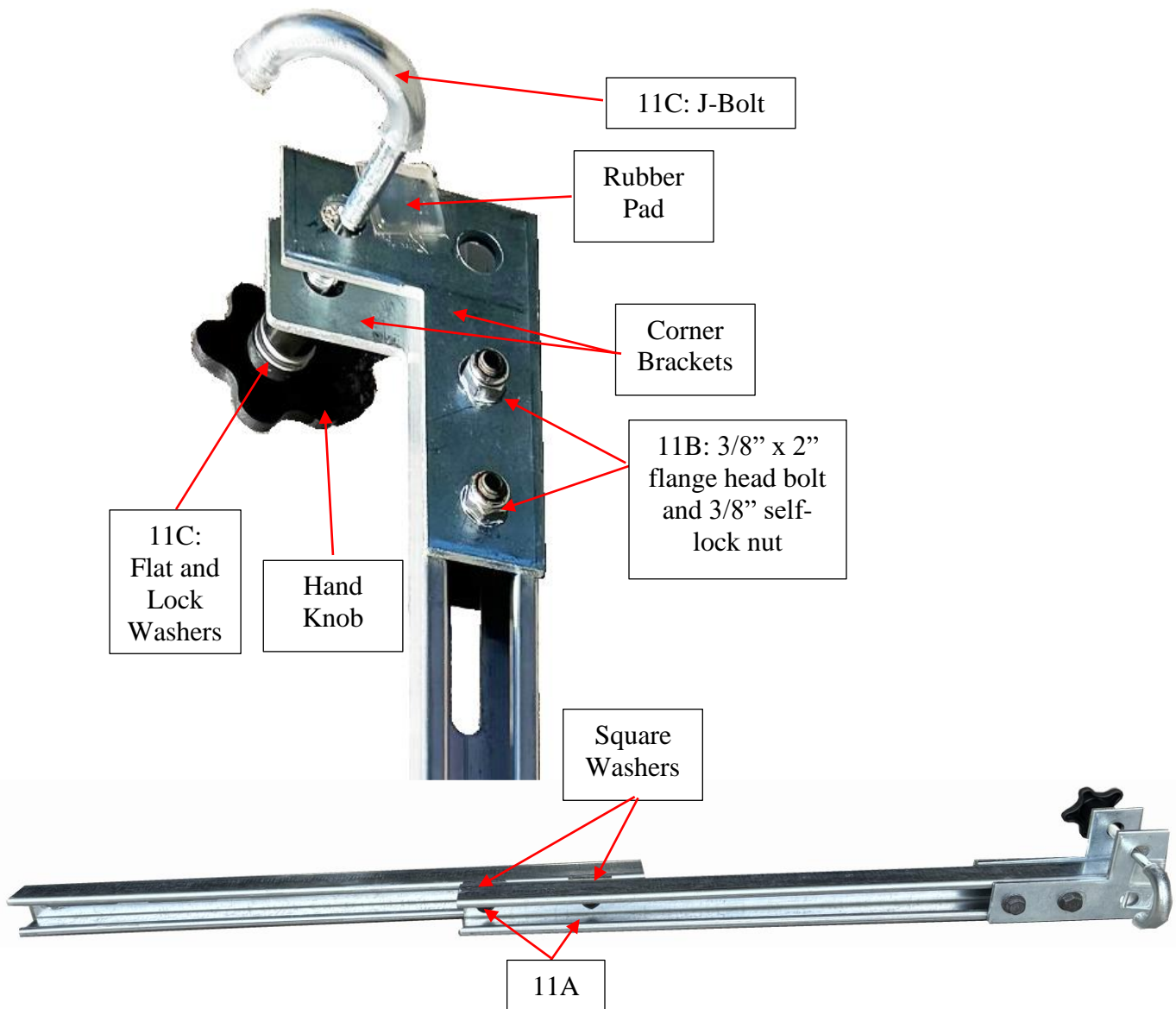

**Step 12: Attach the L-Bracket to the Tilt-Up and the Bike Vertical Assembly to the L-Bracket**

**12A:** Place (5) 3/8" washers under the head of a 3/8" x 3 5/64" hex head bolt with a hole for a hair pin. Place the bolt through the L-Bracket and the Tilt-Up in the hole that is 9" from the outer end of the Tilt-Up. Put a flat washer on the end of the bolt and attach a 3/8" slotted lock nut on the end of the hex head bolt and tighten slightly and put a Hair Pin through a slot in the nut and the hole in the bolt. The nut should be snug but so that the L-Bracket can swivel. The L-Bracket will need to swivel but it should not be loose.

**12B:** Place (1) 3/8" washer under the head of a 3/8" x 1 5/64" hex head bolt with a hole in the end for a cotter pin. Pass the bolt through the bottom slot in the Bike Vertical Bottom and the top hole in the L-Bracket. Attach (4) 3/8" flat washers and a slotted lock nut on the end of the hex head bolt and tighten slightly and put a Cotter Pin through a slot in the nut and the hole in the bolt. The nut should be snug so that the Bike Vertical Bottom can swivel.

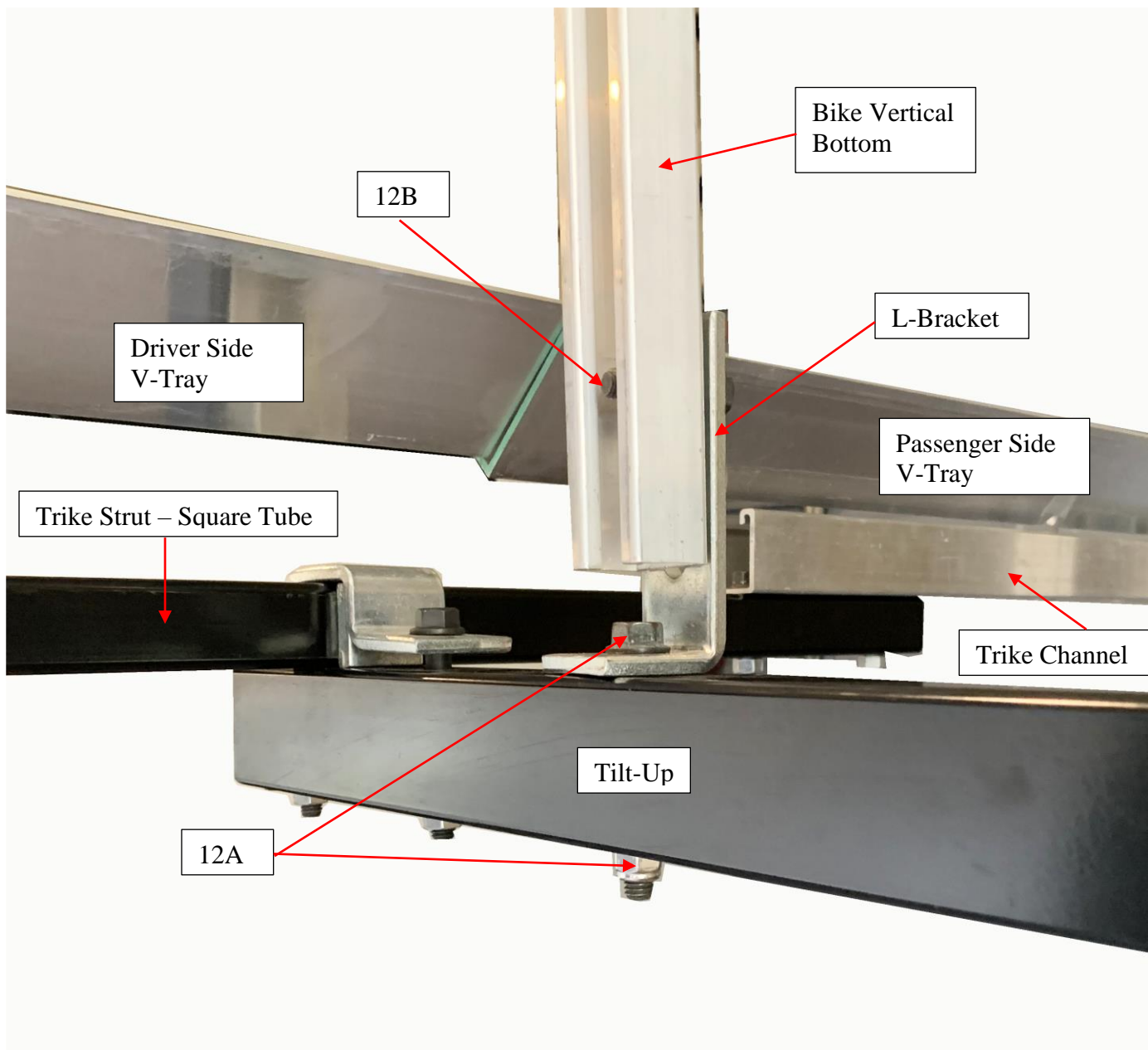

# Picture of Finished Rack





The straps holding the front wheels of the tadpole trike or the rear wheels of the delta trike will be like straps in the picture below.



Straps on both the dual wheels that go around the Crossbar and the wheel of the trike

The straps holding the rear wheel of a tadpole trike or the front wheel of a delta trike is shown below.



Straps that go around the Wheel Stop and the rear tire of a tadpole trike and the front tire on a delta trike





Strap that goes around the Strap Holder and the rear tire

Two straps that go around the Bike Channel and both tires

Strap that goes around the Wheel Stop and the front tire